

**Features**

- Uses CRM(CQ) advanced Trench technology
- Extremely low on-resistance  $R_{DS(on)}$
- Excellent  $Q_g \times R_{DS(on)}$  product(FOM)
- Qualified according to JEDEC criteria

**Applications**

- Motor control and drive
- Battery management
- UPS (Uninterruptible Power Supplies)

**Product Summary**

$V_{DS}$	40V
$R_{DS(on)}$ typ.	1.6mΩ
$I_D$	195A

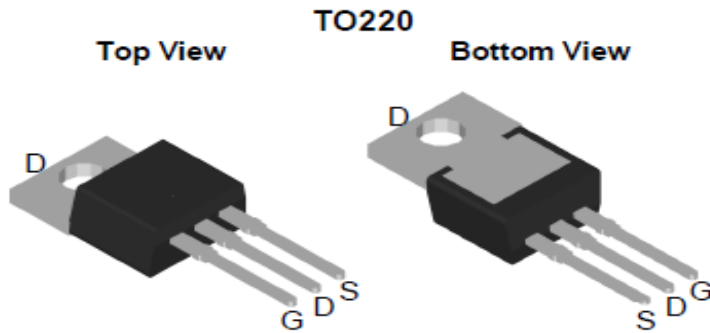
**100% DVDS Tested**
**100% Avalanche Tested**

**Package Marking and Ordering Information**

Part #	Marking	Package	Packing	Reel Size	Tape Width	Qty
CRTT020N04N	CRTT020N04N	TO-220	Tube	N/A	N/A	50pcs

**Absolute Maximum Ratings**

Parameter	Symbol	Value	Unit
Drain-source voltage	$V_{DS}$	40	V
Continuous drain current $T_C = 25^\circ\text{C}$ (Silicon limit) $T_C = 25^\circ\text{C}$ (Package limit) $T_C = 100^\circ\text{C}$ (Silicon limit)	$I_D$	285 195 201	A
Pulsed drain current ( $T_C = 25^\circ\text{C}$ , $t_p$ limited by $T_{jmax}$ )	$I_{D\ pulse}$	780	A
Avalanche energy, single pulse ( $L=0.5\text{mH}$ , $R_g=25\Omega$ )	$E_{AS}$	650	mJ
Gate-Source voltage	$V_{GS}$	$\pm 25$	V
Power dissipation ( $T_C = 25^\circ\text{C}$ )	$P_{tot}$	284	W
Operating junction and storage temperature	$T_j, T_{stg}$	-55...+175	$^\circ\text{C}$
Soldering temperature, wave soldering only allowed at leads (1.6mm from case for 10s)	$T_{sold}$	260	$^\circ\text{C}$

**Thermal Resistance**

Parameter	Symbol	Max	Unit
Thermal resistance, junction – case.	$R_{thJC}$	0.53	°C/W
Thermal resistance, junction – ambient(min. footprint)	$R_{thJA}^*$	84	

**Electrical Characteristic (at  $T_j = 25\text{ }^\circ\text{C}$ , unless otherwise specified)**

Parameter	Symbol	Value			Unit	Test Condition
		min.	typ.	max.		

**Static Characteristic**

Drain-source breakdown voltage	$BV_{DSS}$	40	-	-	V	$V_{GS}=0V, I_D=250\mu A$
Gate threshold voltage	$V_{GS(th)}$	2.5	3	3.5	V	$V_{DS}=V_{GS}, I_D=250\mu A$
Zero gate voltage drain current	$I_{DSS}$	-	0.05	1	$\mu A$	$V_{DS}=40V, V_{GS}=0V$ $T_j=25^\circ C$ $T_j=150^\circ C$
Gate-source leakage current	$I_{GSS}$	-	$\pm 10$	$\pm 100$	nA	$V_{GS}=\pm 25V, V_{DS}=0V$
Drain-source on-state resistance	$R_{DS(on)}$	-	1.6 2.9	2.0 3.5	$m\Omega$	$V_{GS}=10V, I_D=100A,$ $T_j=25^\circ C$ $T_j=175^\circ C$
Transconductance	$g_{fs}$	-	334	-	S	$V_{DS}=10V, I_D=100A$

**Dynamic Characteristic**

Input Capacitance	$C_{iss}$	-	11900	-	pF	$V_{GS}=0V, V_{DS}=20V,$ $f=1MHz$
Output Capacitance	$C_{oss}$	-	1429	-		
Reverse Transfer Capacitance	$C_{rss}$	-	261	-		
Gate Total Charge	$Q_G$	-	189	-	nC	$V_{GS}=10V, V_{DS}=20V,$ $I_D=100A, f=1MHz$
Gate-Source charge	$Q_{gs}$	-	59	-		
Gate-Drain charge	$Q_{gd}$	-	38	-		
Turn-on delay time	$t_{d(on)}$	-	16	-	ns	$V_{GS}=10V, V_{DD}=34V,$ $R_{G\_ext}=2.7\Omega, I_D=30A$
Rise time	$t_r$	-	90	-		
Turn-off delay time	$t_{d(off)}$	-	192	-		
Fall time	$t_f$	-	83	-		
Gate resistance	$R_G$	-	4.9	-	$\Omega$	$V_{GS}=0V, V_{DS}=0V,$ $f=1MHz$

**Body Diode Characteristic**

Parameter	Symbol	Value			Unit	Test Condition
		min.	typ.	max.		
Body Diode Forward Voltage	$V_{SD}$	-	0.9	1.3	V	$V_{GS}=0V, I_{SD}=100A$
Body Diode Continuous Forward Current	$I_S$			284	A	$T_C = 25^{\circ}C$
Body Diode Reverse Recovery Time	$t_{rr}$	-	42	-	ns	$I_F=50A, dI/dt=100A/\mu s$
Body Diode Reverse Recovery Charge	$Q_{rr}$	-	45	-	nC	

\*The value of  $R_{thJA}$  is measured by placing the device in a still air box which is one cubic foot.

## Typical Performance Characteristics

Fig 1: Output Characteristics

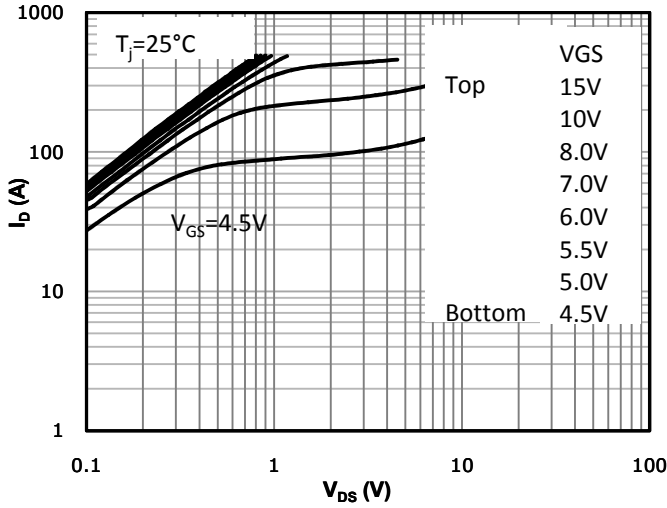

Fig 2: Transfer Characteristics

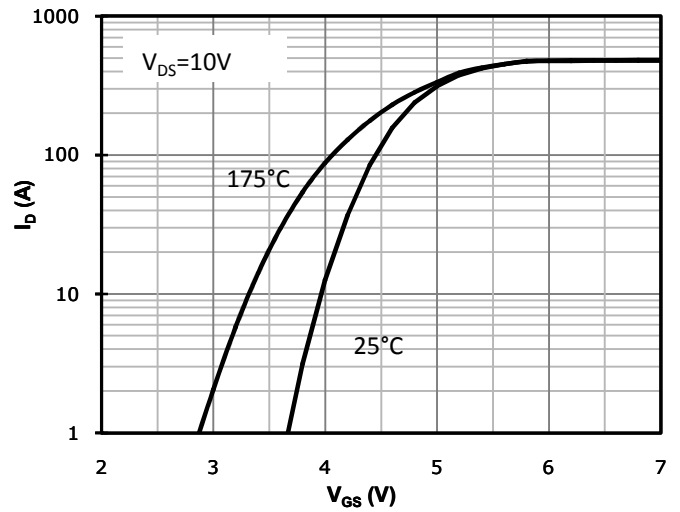

Fig 3:  $R_{DS(on)}$  vs Drain Current and Gate Voltage

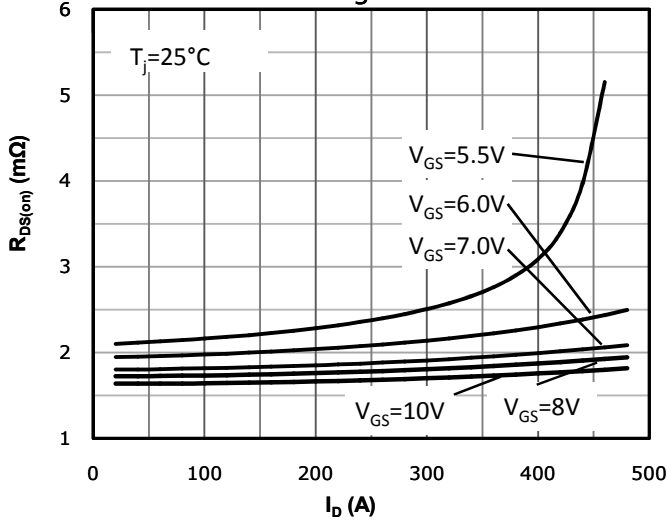

Fig 4:  $R_{DS(on)}$  vs Gate Voltage

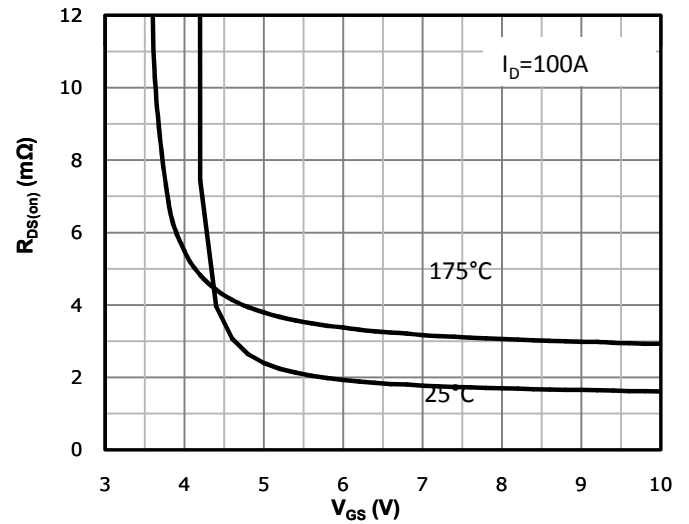

Fig 5:  $R_{DS(on)}$  vs. Temperature

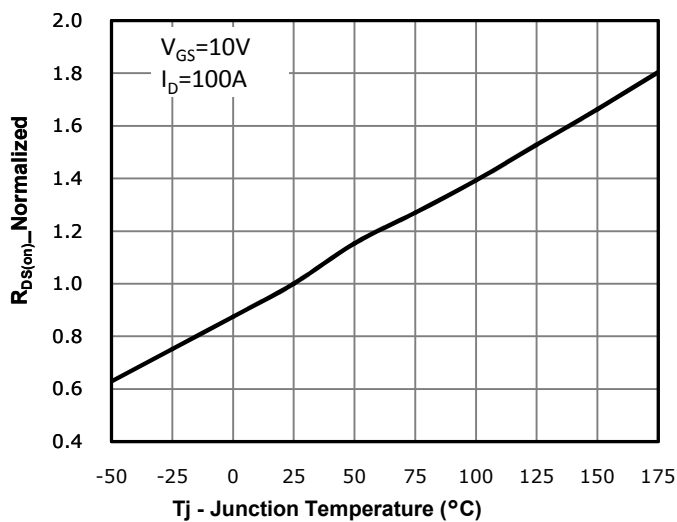

Fig 6: Capacitance Characteristics

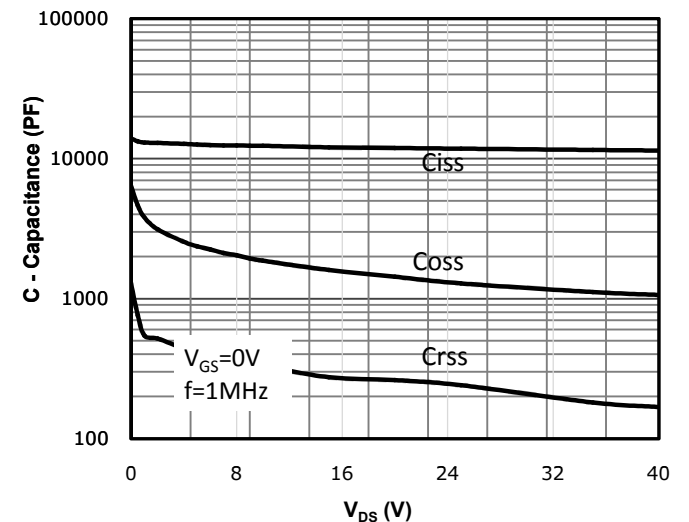

Fig 7: Gate Charge Characteristics

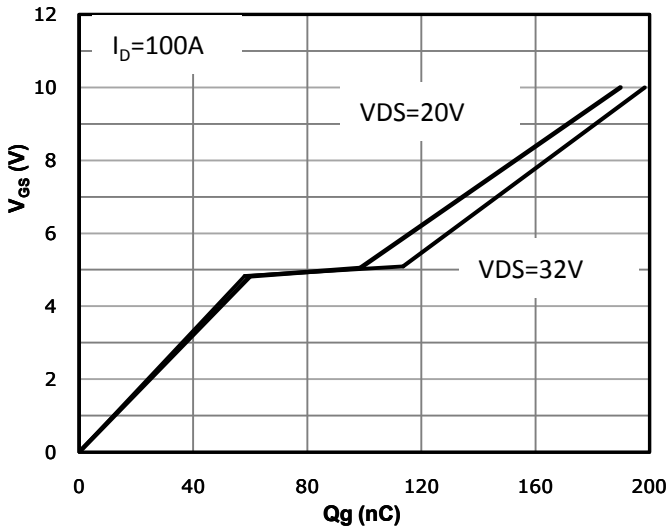

Fig 8: Body-diode Forward Characteristics

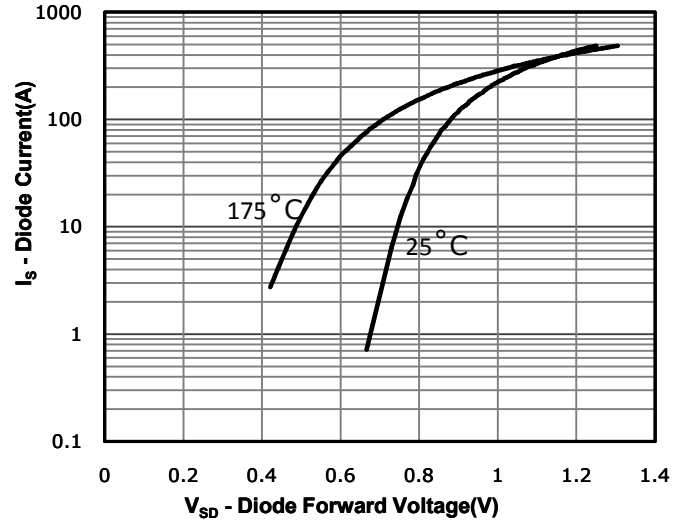

Fig 9: Power Dissipation

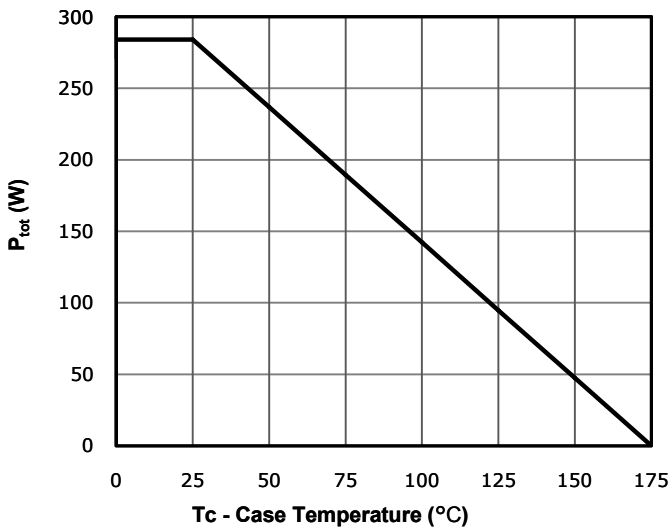

Fig 10: Drain Current Derating

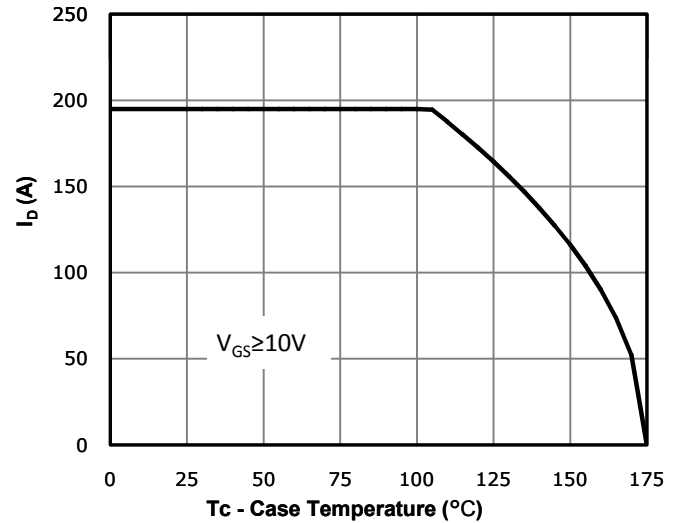

Fig 11: Safe Operating Area

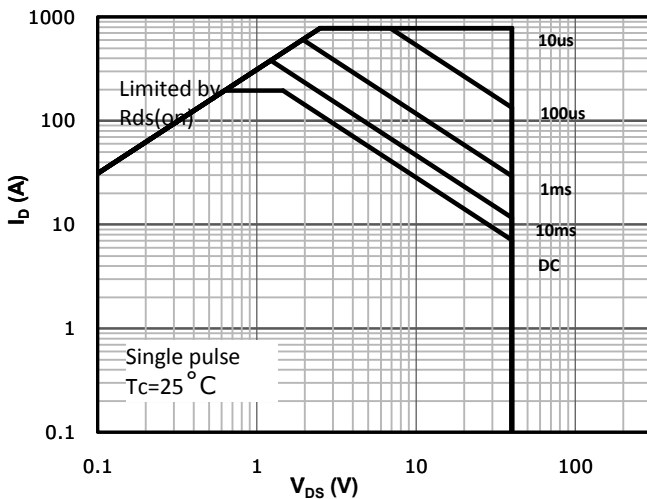
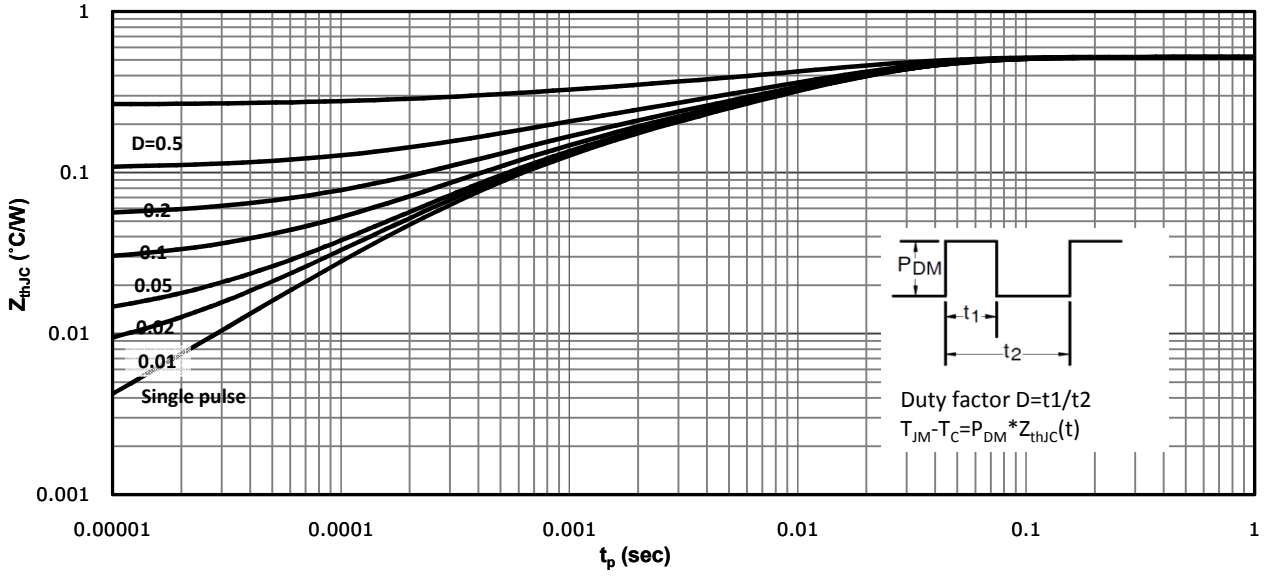
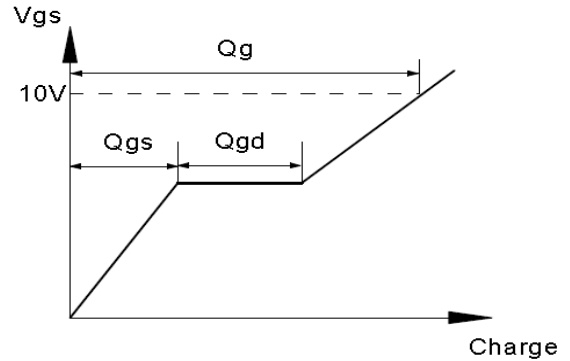

Fig 12: Max. Transient Thermal Impedance



## Test Circuit & Waveform

Gate Charge Test Circuit & Waveform



Resistive Switching Test Circuit & Waveforms

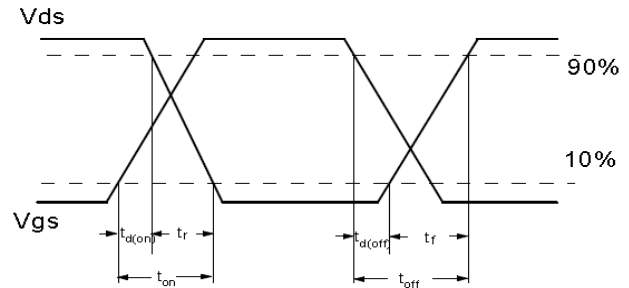
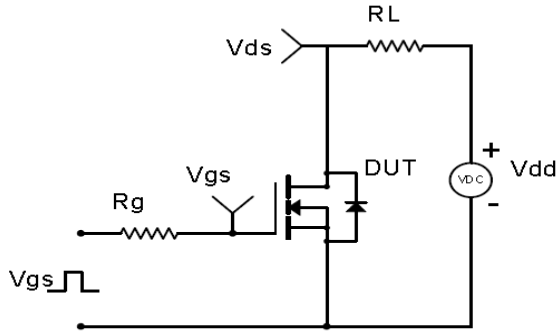

Unclamped Inductive Switching (UIS) Test Circuit & Waveforms

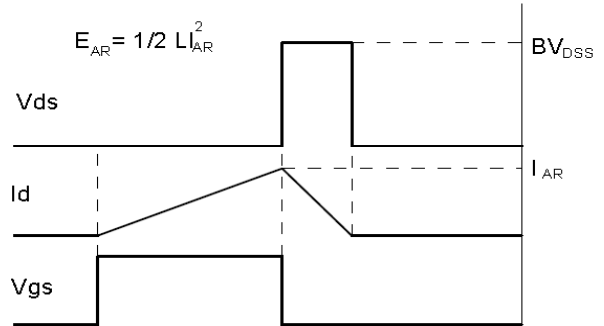
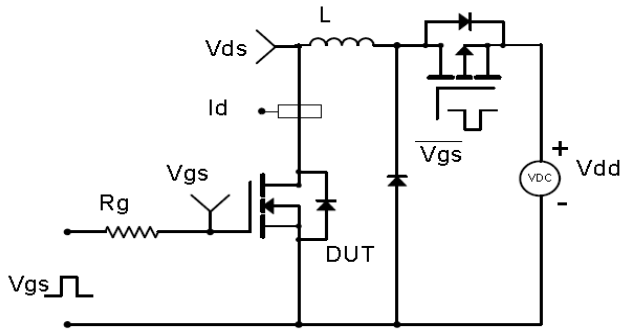

Diode Recovery Test Circuit & Waveforms

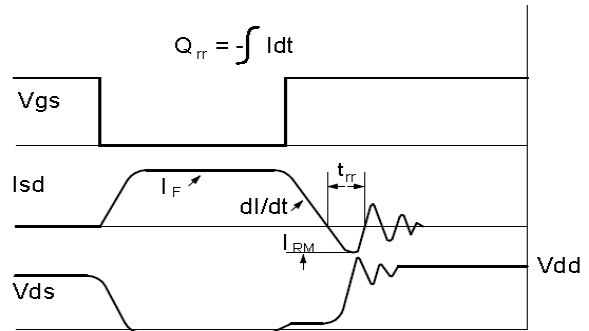
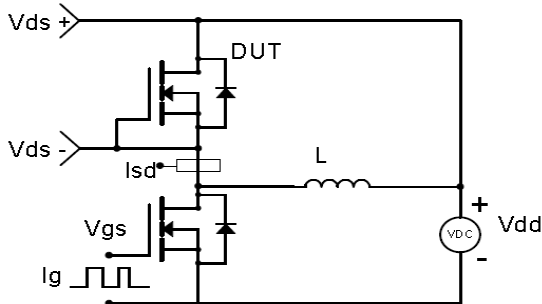

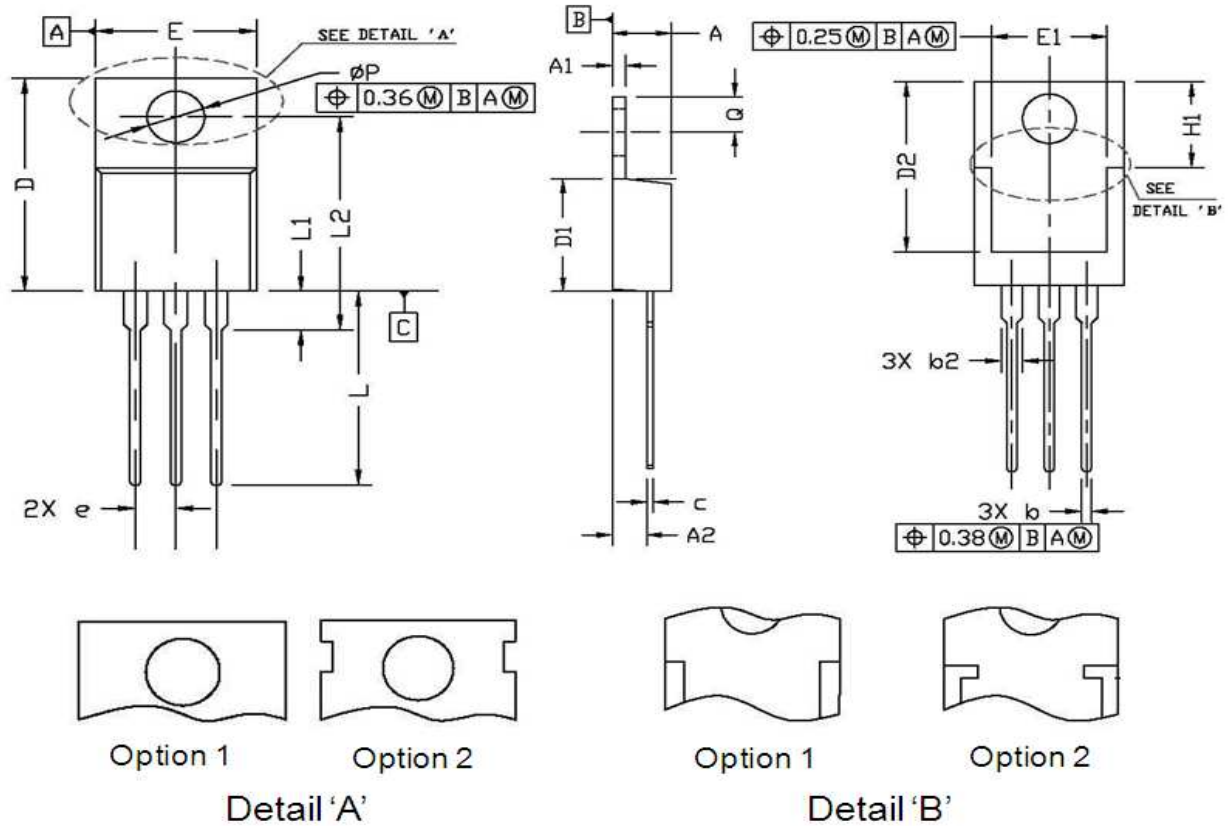
**Package Outline: TO-220-3L**

Symbol	Dimensions In Millimeters		Dimensions In Inches	
	Min.	Max.	Min.	Max.
A	4.30	4.80	0.169	0.189
A1	1.20	1.45	0.047	0.057
A2	2.20	2.90	0.087	0.114
b	0.69	0.95	0.027	0.037
b2	1.00	1.60	0.039	0.063
c	0.33	0.65	0.013	0.026
D	14.70	16.20	0.579	0.638
D1	8.59	9.65	0.338	0.380
D2	11.75	13.60	0.463	0.535
e	2.54 BSC.		0.100 BSC.	
E	9.60	10.60	0.378	0.417
E1	7.00	8.46	0.276	0.333
H1	6.20	7.00	0.244	0.276
L	12.60	14.80	0.496	0.583
L1	2.70	3.80	0.106	0.150
L2	12.13	16.50	0.478	0.650
Q	2.40	3.10	0.094	0.122
P	3.50	3.90	0.138	0.154



---

## Revision History

Revision	Date	Major changes
1.0	2019/9/16	Release of Formal version

## Disclaimer

Unless otherwise specified in the datasheet, the product is designed and qualified as a standard commercial product and is not intended for use in applications that require extraordinary levels of quality and reliability, such as automotive, aviation/aerospace and life-support devices or systems.

Any and all semiconductor products have certain probability to fail or malfunction, which may result in personal injury, death or property damage. Customer are solely responsible for providing adequate safe measures when design their systems.

CRM(CQ) reserves the right to improve product design, function and reliability without notice.