

### Features

- 85V/130A,  
 $R_{DS(ON)} = 4.4m\Omega(Typ.)@V_{GS}=10V$
- Excellent  $Q_G \times R_{DS(on)}$  product(FOM)
- SGT Technology
- 100% Avalanche Tested

### Applications

- DC-DC Converters and Off-line UPS
- Power Management in Inverter System



Halogen-Free

### Pin Description

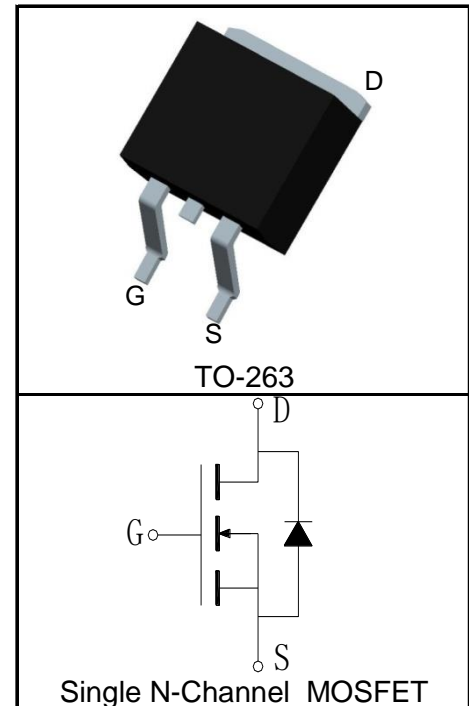

### Absolute Maximum Ratings

Symbol	Parameter	Rating	Unit	
<b>Common Ratings</b> ( $T_C=25^\circ C$ Unless Otherwise Noted)				
$V_{DSS}$	Drain-Source Voltage	85	V	
$V_{GSS}$	Gate-Source Voltage	$\pm 20$		
$T_J$	Maximum Junction Temperature	175	$^\circ C$	
$T_{STG}$	Storage Temperature Range	-55 to 175	$^\circ C$	
$I_S$	Diode Continuous Forward Current	$T_C=25^\circ C$	130	A
<b>Mounted on Large Heat Sink</b>				
$I_{DP}^{①}$	300 $\mu s$ Pulse Drain Current Tested	$T_C=25^\circ C$	520	A
$I_D^{②}$	Continuous Drain Current( $V_{GS}=10V$ )	$T_C=25^\circ C$	130	A
		$T_C=100^\circ C$	92	
$P_D$	Maximum Power Dissipation	$T_C=25^\circ C$	150	W
		$T_C=100^\circ C$	75	
$R_{\theta JC}$	Thermal Resistance-Junction to Case	1	$^\circ C/W$	
$R_{\theta JA}^{③}$	Thermal Resistance-Junction to Ambient	62.5	$^\circ C/W$	
<b>Drain-Source Avalanche Ratings</b>				
$E_{AS}^{④}$	Avalanche Energy, Single Pulsed	256	mJ	

**Electrical Characteristics** ( $T_C=25^\circ\text{C}$  Unless Otherwise Noted)

Symbol	Parameter	Test Condition	KS9203GAT			Unit
			Min.	Typ.	Max.	
<b>Static Characteristics</b>						
$BV_{DSS}$	Drain-Source Breakdown Voltage	$V_{GS}=0V, I_{DS}=250\mu A$	85	92		V
$I_{DSS}$	Zero Gate Voltage Drain Current	$V_{DS}=80V, V_{GS}=0V$			1	$\mu A$
		$T_J=125^\circ C$			30	
$V_{GS(th)}$	Gate Threshold Voltage	$V_{DS}=V_{GS}, I_{DS}=250\mu A$	2	3	4	V
$I_{GSS}$	Gate Leakage Current	$V_{GS}=\pm 20V, V_{DS}=0V$			$\pm 100$	nA
$R_{DS(ON)}^{(5)}$	Drain-Source On-state Resistance	$V_{GS}=10V, I_{DS}=40A$		4.4	5.5	m $\Omega$
<b>Diode Characteristics</b>						
$V_{SD}^{(5)}$	Diode Forward Voltage	$I_{SD}=40A, V_{GS}=0V$		0.88	1.2	V
$t_{rr}$	Reverse Recovery Time	$I_{SD}=40A, dI_{SD}/dt=100A/\mu s$		28		ns
$Q_{rr}$	Reverse Recovery Charge			41		nC
<b>Dynamic Characteristics<sup>(6)</sup></b>						
$R_G$	Gate Resistance	$V_{GS}=0V, V_{DS}=0V, F=1MHz$		2.5		$\Omega$
$C_{iss}$	Input Capacitance	$V_{GS}=0V,$ $V_{DS}=40V,$ Frequency=1.0MHz		2455		pF
$C_{oss}$	Output Capacitance			920		
$C_{riss}$	Reverse Transfer Capacitance			45		
$t_{d(ON)}$	Turn-on Delay Time	$V_{DD}=40V, I_{DS}=40A,$ $V_{GEN}=10V, R_G=3\Omega$		12		ns
$t_r$	Turn-on Rise Time			19		
$t_{d(OFF)}$	Turn-off Delay Time			25		
$t_f$	Turn-off Fall Time			10		
<b>Gate Charge Characteristics<sup>(6)</sup></b>						
$Q_g$	Total Gate Charge	$V_{DS}=40V, V_{GS}=10V,$ $I_{DS}=40A$		39		nC
$Q_{gs}$	Gate-Source Charge			9		
$Q_{gd}$	Gate-Drain Charge			7		

- Notes:
- ① Pulse width limited by safe operating area.
  - ② Calculated continuous current based on maximum allowable junction temperature. The package limitation current is 75A.
  - ③ When mounted on 1 inch square copper board,  $t \leq 10\text{sec}$ . The value in any given application depends on the user's specific board design.
  - ④ Limited by  $T_{Jmax}, I_{AS}=32A, L=0.5mH, V_{DD}=48V, R_G=25\Omega$ , Starting  $T_J=25^\circ C$ .
  - ⑤ Pulse test; Pulse width  $\leq 300\mu s$ , duty cycle  $\leq 2\%$ .
  - ⑥ Guaranteed by design, not subject to production testing.

**Ordering and Marking Information**

Device	Package	Packaging	Quantity	Reel Size	Tape width
KS9203GAT	TO-263	Tape&Reel	800	13"	24mm

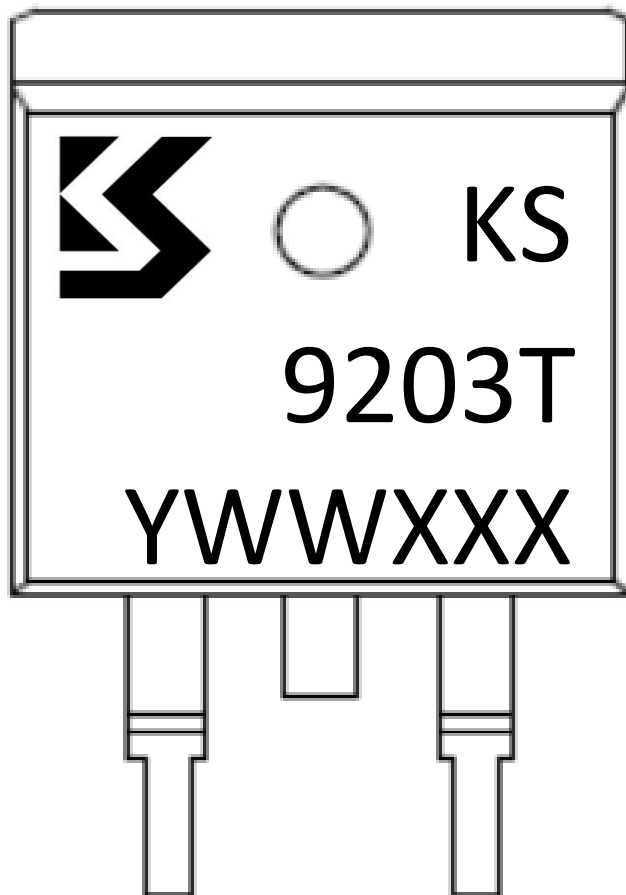

Y =Year,2017-A,2018-B,etc.

WW =Week.

XXX =Lot number.

Typical Characteristics

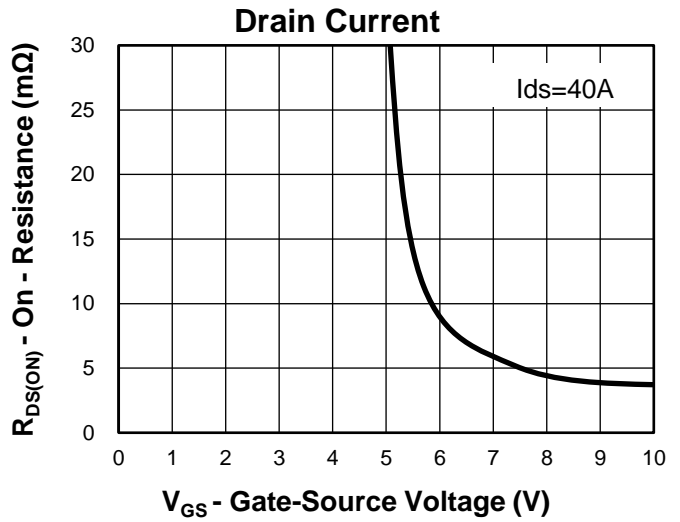
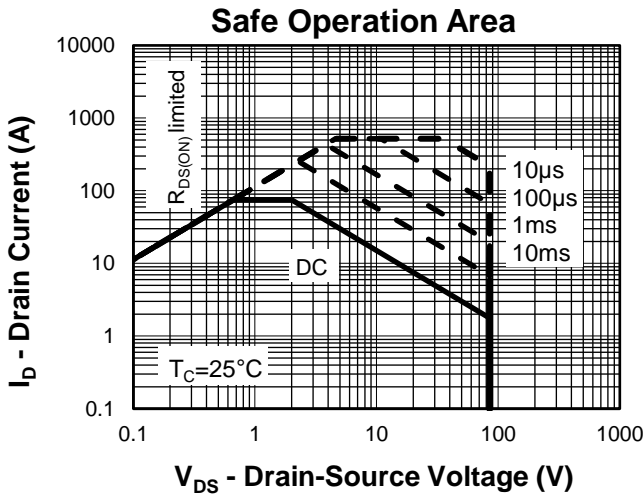
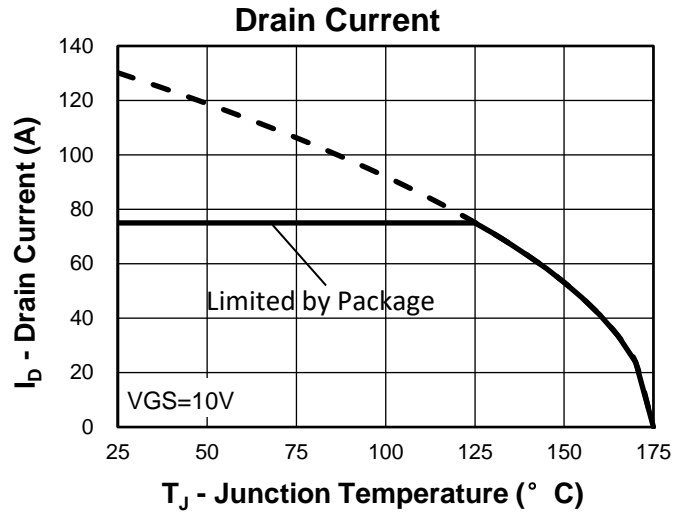
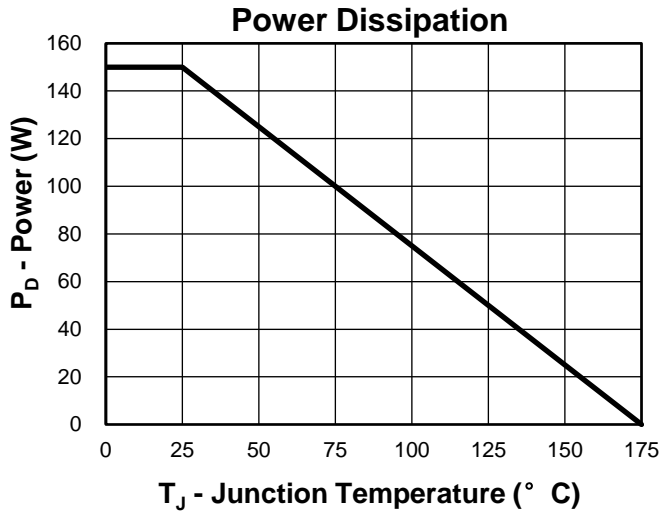

Thermal Transient Impedance

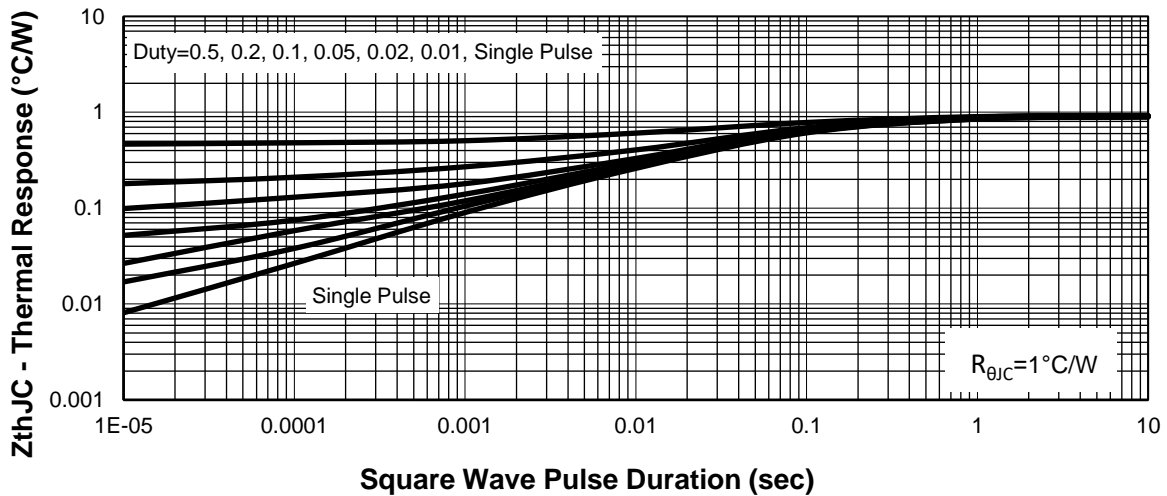

### Typical Characteristics

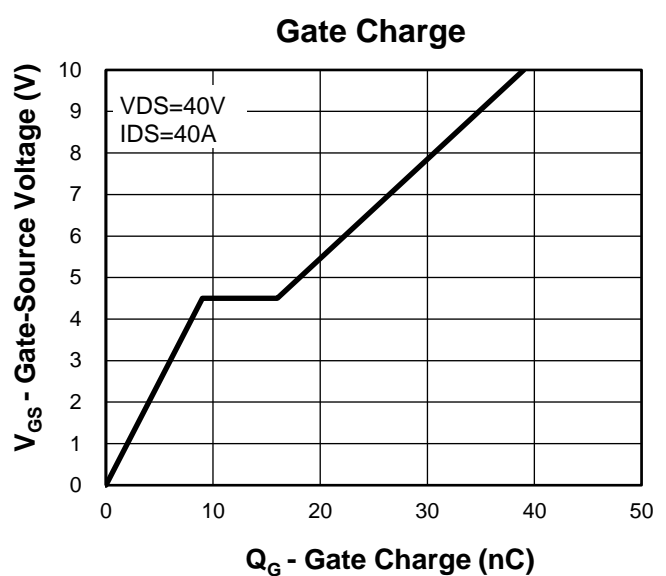
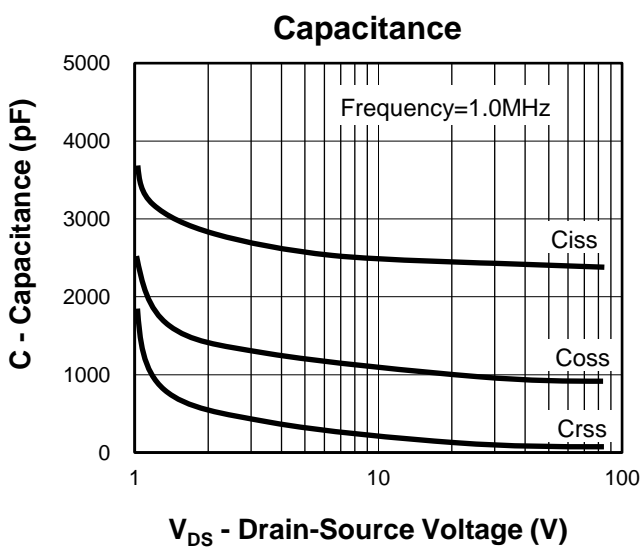
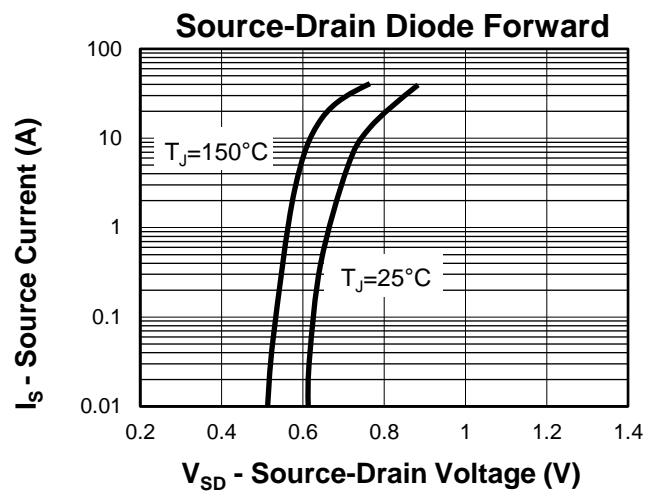
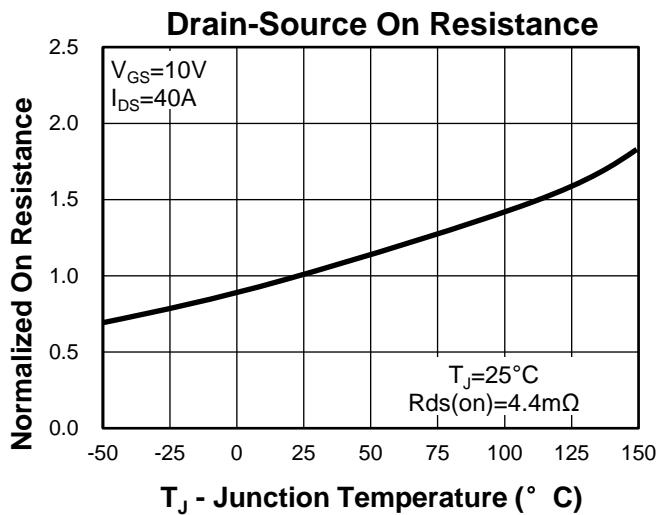
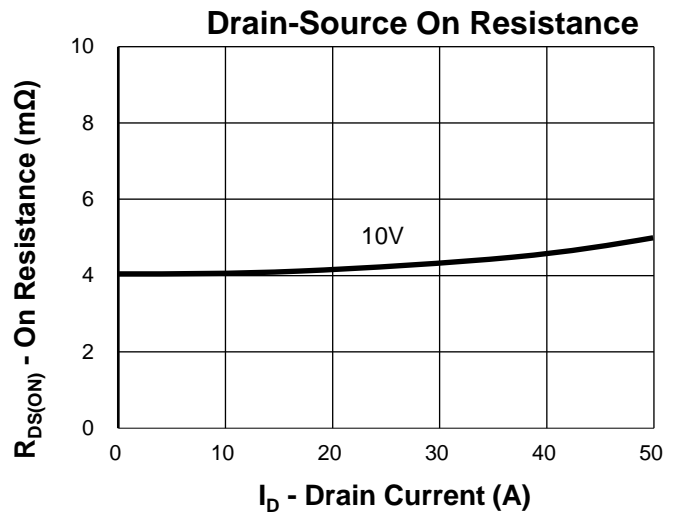
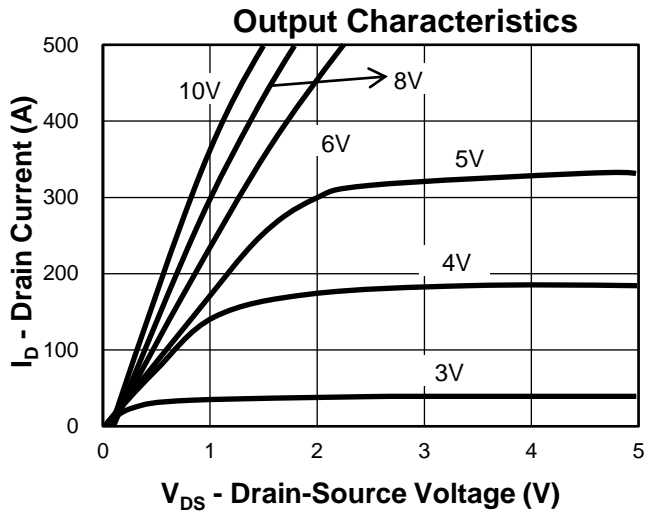

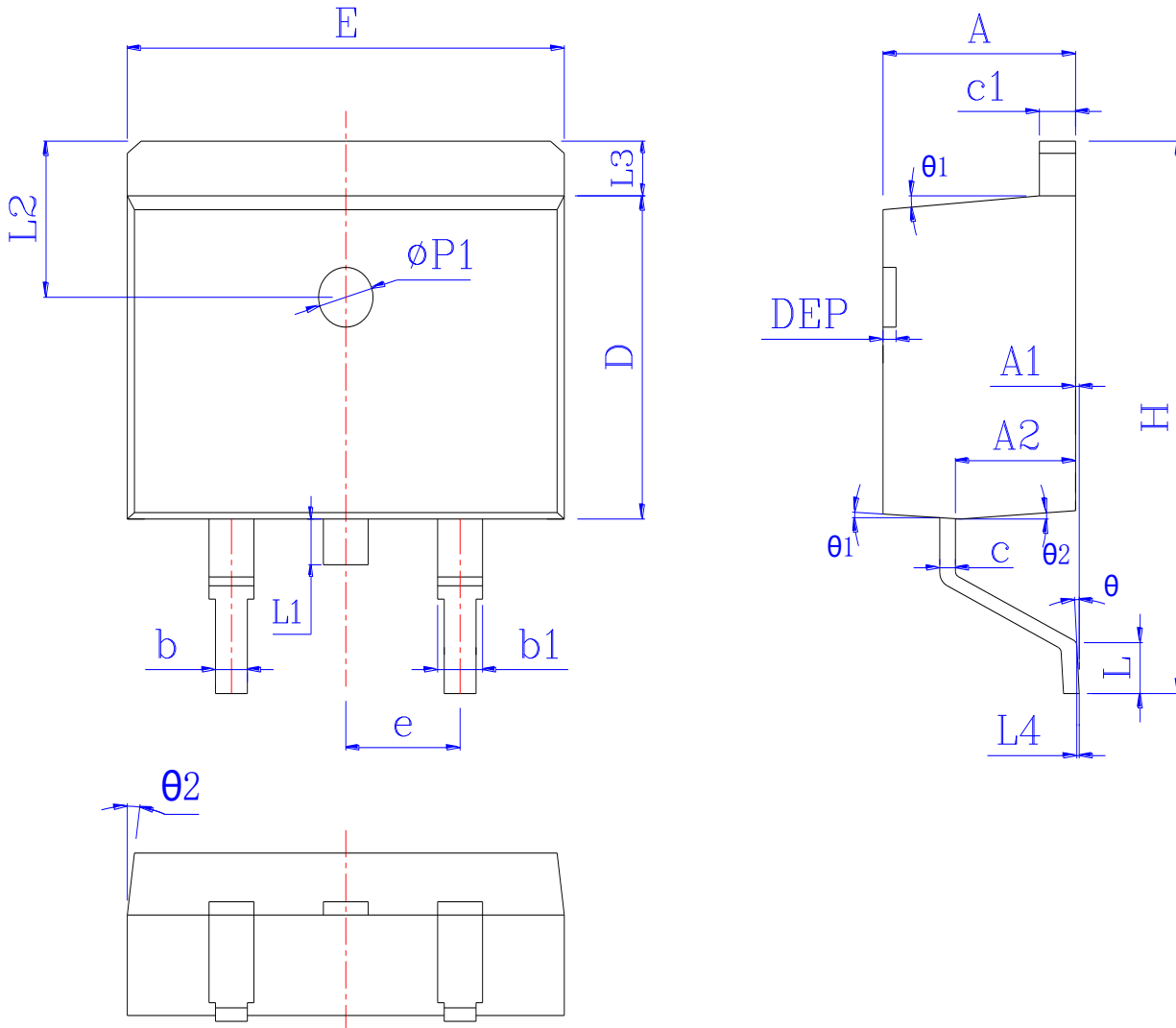
**Package Information**
**TO-263**

SYMBOL	MM			INCH			SYMBOL	MM			INCH		
	MIN	NOM	MAX	MIN	NOM	MAX		MIN	NOM	MAX	MIN	NOM	MAX
A	4.40	4.55	4.72	0.173	0.179	0.186	L	1.94	2.30	2.60	0.076	0.091	0.102
A1	0.00	0.10	0.25	0.000	0.005	0.010	L3	1.17	1.29	1.40	0.046	0.051	0.055
A2	2.59	2.69	2.79	0.102	0.106	0.110	L1	*	*	1.70	*	*	0.067
b	0.76	*	0.90	0.030	*	0.035	L4	0.25 BSC			0.01 BSC		
b1	1.22	*	1.36	0.048	*	0.054	L2	2.50 REF			0.098 REF		
c	0.33	*	0.47	0.013	*	0.019	$\theta$	0°	*	8°	0°	*	8°
c1	1.22	*	1.32	0.048	*	0.052	$\theta1$	5°	7°	9°	5°	7°	9°
D	8.60	*	9.29	0.339	*	0.366	$\theta2$	1°	3°	5°	1°	3°	5°
E	9.95	*	10.26	0.392	*	0.404	DEP	0.05	0.10	0.20	0.002	0.004	0.008
e	2.54BSC			0.100BSC			$\phi P1$	1.40	1.50	1.60	0.055	0.059	0.063
H	14.70	15.10	15.79	0.579	0.594	0.622							

### Avalanche Test Circuit and Waveforms



### Switching Time Test Circuit and Waveforms



### Diode Recovery Test Circuit and Waveforms

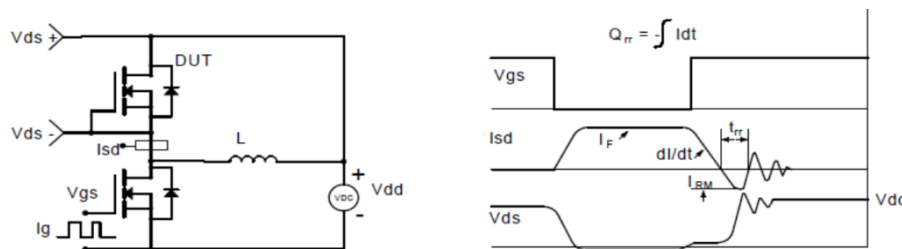

### Gate Charge Test Circuit and Waveform

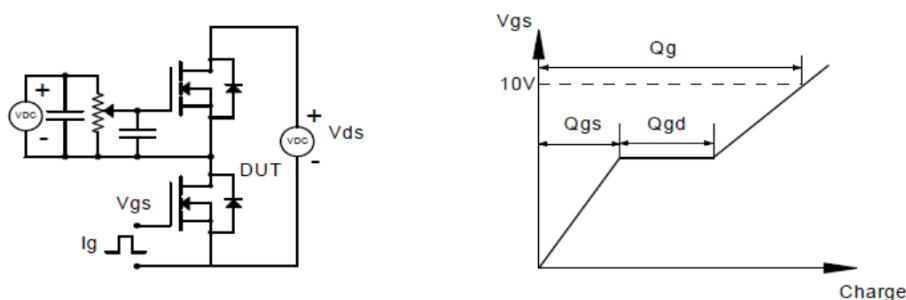

### Customer Service

Kwansemi Semiconductor Co.,Ltd

Email:Sales@kwansemi.com

Web:www.kwansemi.com

### DISCLAIMER:

Kwansemi reserves the right to change the specifications and circuitry without notice at any time. The Products are not designed for use in hostile environments, including, without limitation, aircraft, nuclear power generation, medical appliances, and devices or systems in which malfunction of any Product can reasonably be expected to result in a personal injury. Seller's customers using or selling Seller's products for use in such applications do so at their own risk and agree to fully defend and indemnify Seller.