

### General Description

These N-Channel enhancement mode power field effect transistors are using trench DMOS technology. This advanced technology has been especially tailored to minimize on-state resistance, provide superior switching performance, and withstand high energy pulse in the avalanche and commutation mode. These devices are well suited for high efficiency fast switching applications.

BVDSS	RDSON	ID
100V	4.2mΩ	150A

### Features

- 100V,150A,  $R_{DS(ON)} = 4.2m\Omega @ V_{GS} = 10V$
- Improved dv/dt capability
- Fast switching
- 100% EAS Guaranteed
- Green Device Available

### TO220 Pin Configuration

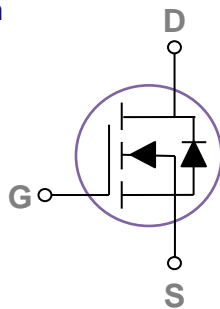

### Applications

- Networking
- Load Switch
- LED applications
- Quick Charger

### Absolute Maximum Ratings $T_c=25^\circ\text{C}$ unless otherwise noted

Symbol	Parameter	Rating	Units
$V_{DS}$	Drain-Source Voltage	100	V
$V_{GS}$	Gate-Source Voltage	+20/-12	V
$I_D$	Drain Current – Continuous ( $T_c=25^\circ\text{C}$ )	150	A
	Drain Current – Continuous ( $T_c=100^\circ\text{C}$ )	95	A
$I_{DM}$	Drain Current – Pulsed <sup>1</sup>	600	A
EAS	Single Pulse Avalanche Energy <sup>2</sup>	378	mJ
IAS	Single Pulse Avalanche Current <sup>2</sup>	87	A
$P_D$	Power Dissipation ( $T_c=25^\circ\text{C}$ )	275	W
	Power Dissipation – Derate above $25^\circ\text{C}$	2.22	W/ $^\circ\text{C}$
$T_{STG}$	Storage Temperature Range	-50 to 150	$^\circ\text{C}$
$T_J$	Operating Junction Temperature Range	-50 to 150	$^\circ\text{C}$

### Thermal Characteristics

Symbol	Parameter	Typ.	Max.	Unit
$R_{\theta JA}$	Thermal Resistance Junction to ambient	---	62	$^\circ\text{C}/\text{W}$
$R_{\theta JC}$	Thermal Resistance Junction to Case	---	0.45	$^\circ\text{C}/\text{W}$

**Electrical Characteristics (T<sub>J</sub>=25 °C, unless otherwise noted)**
**Off Characteristics**

Symbol	Parameter	Conditions	Min.	Typ.	Max.	Unit
BV <sub>DSS</sub>	Drain-Source Breakdown Voltage	V <sub>GS</sub> =0V , I <sub>D</sub> =250uA	100	---	---	V
I <sub>DSS</sub>	Drain-Source Leakage Current	V <sub>DS</sub> =100V , V <sub>GS</sub> =0V , T <sub>J</sub> =25°C	---	---	1	uA
		V <sub>DS</sub> =80V , V <sub>GS</sub> =0V , T <sub>J</sub> =85°C	---	---	10	uA
I <sub>GSS</sub>	Gate-Source Leakage Current	V <sub>GS</sub> =20V , V <sub>DS</sub> =0V	---	---	100	nA

**On Characteristics**

R <sub>DS(ON)</sub>	Static Drain-Source On-Resistance	V <sub>GS</sub> =10V , I <sub>D</sub> =20A	---	3.5	4.2	mΩ
		V <sub>GS</sub> =4.5V , I <sub>D</sub> =15A	---	4.5	6.0	mΩ
V <sub>GS(th)</sub>	Gate Threshold Voltage	V <sub>GS</sub> =V <sub>DS</sub> , I <sub>D</sub> =250uA	1.2	1.8	2.5	V
g <sub>fs</sub>	Forward Transconductance	V <sub>DS</sub> =10V , I <sub>D</sub> =3A	---	20	---	S

**Dynamic and switching Characteristics**

Q <sub>g</sub>	Total Gate Charge <sup>3, 4</sup>	V <sub>DS</sub> =80V , V <sub>GS</sub> =10V , I <sub>D</sub> =10A	---	110	165	nC
Q <sub>gs</sub>	Gate-Source Charge <sup>3, 4</sup>		---	11.5	18	
Q <sub>gd</sub>	Gate-Drain Charge <sup>3, 4</sup>		---	28	42	
T <sub>d(on)</sub>	Turn-On Delay Time <sup>3, 4</sup>	V <sub>DD</sub> =50V , V <sub>GS</sub> =10V , R <sub>G</sub> =6Ω I <sub>D</sub> =1A	---	23	46	ns
T <sub>r</sub>	Rise Time <sup>3, 4</sup>		---	32	64	
T <sub>d(off)</sub>	Turn-Off Delay Time <sup>3, 4</sup>		---	157	320	
T <sub>f</sub>	Fall Time <sup>3, 4</sup>		---	115	230	
C <sub>iss</sub>	Input Capacitance	V <sub>DS</sub> =25V , V <sub>GS</sub> =0V , F=1MHz	---	6680	13300	pF
C <sub>oss</sub>	Output Capacitance		---	1690	3380	
C <sub>rss</sub>	Reverse Transfer Capacitance		---	78	156	
R <sub>g</sub>	Gate resistance	V <sub>GS</sub> =0V , V <sub>DS</sub> =0V , F=1MHz	---	1.9	---	Ω

**Drain-Source Diode Characteristics and Maximum Ratings**

Symbol	Parameter	Conditions	Min.	Typ.	Max.	Unit
I <sub>S</sub>	Continuous Source Current	V <sub>G</sub> =V <sub>D</sub> =0V , Force Current	---	---	150	A
I <sub>SM</sub>	Pulsed Source Current		---	---	300	A
V <sub>SD</sub>	Diode Forward Voltage	V <sub>GS</sub> =0V , I <sub>S</sub> =1A , T <sub>J</sub> =25°C	---	---	1	V

Note :

1. Repetitive Rating : Pulsed width limited by maximum junction temperature.
2. V<sub>DD</sub>=25V, V<sub>GS</sub>=10V, L=0.1mH, I<sub>AS</sub>=87A., R<sub>G</sub>=25Ω, Starting T<sub>J</sub>=25°C.
3. The data tested by pulsed , pulse width ≤ 300us , duty cycle ≤ 2%.
4. Essentially independent of operating temperature.

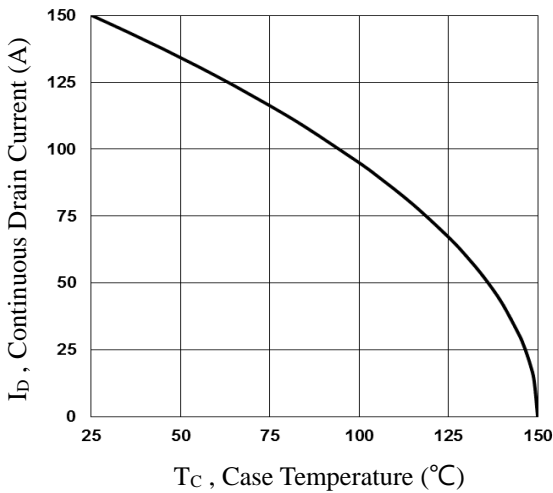

**Fig.1 Continuous Drain Current vs.  $T_c$**

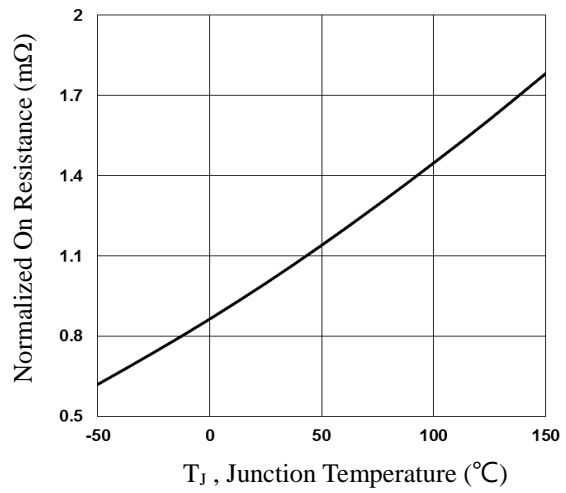

**Fig.2 Normalized  $R_{DS(on)}$  vs.  $T_j$**

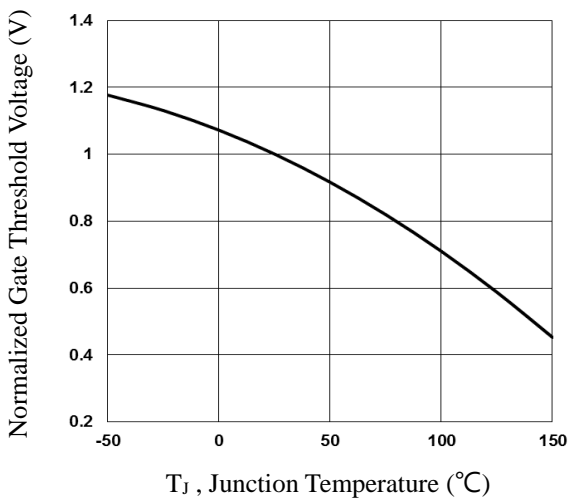

**Fig.3 Normalized  $V_{th}$  vs.  $T_j$**

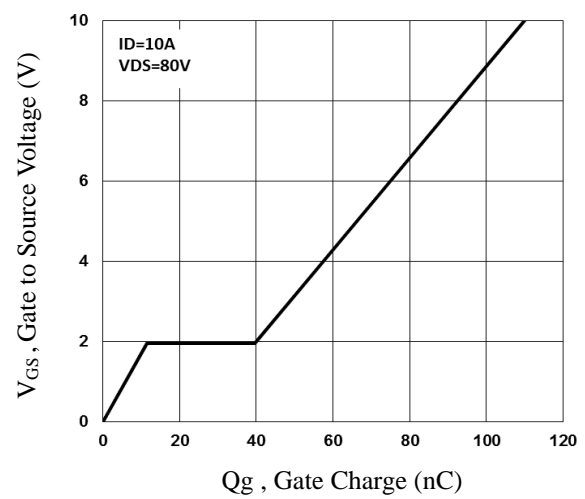

**Fig.4 Gate Charge Characteristics**

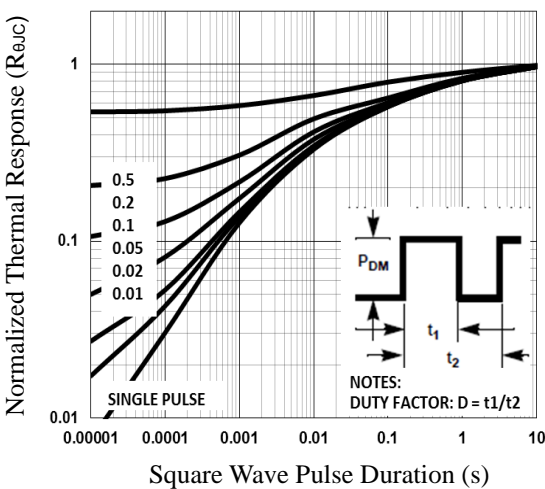

**Fig.5 Normalized Transient Impedance**

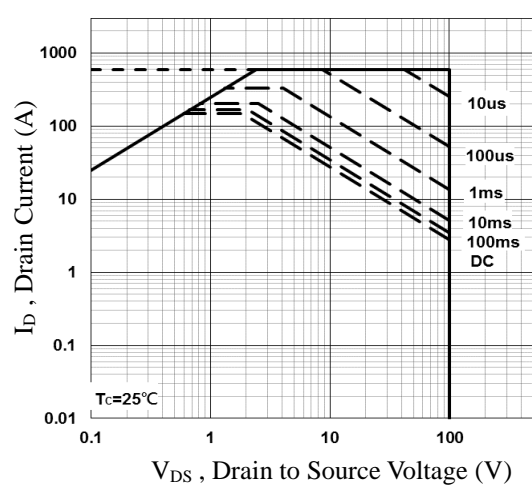

**Fig.6 Maximum Safe Operation Area**

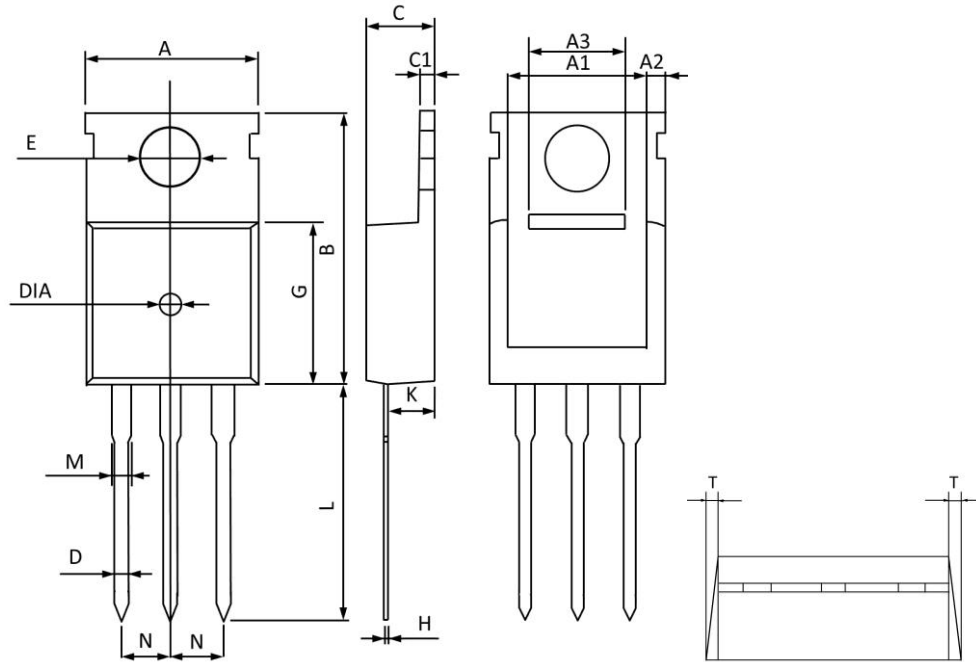

**Fig.7 Switching Time Waveform**



**Fig.8 Gate Charge Waveform**

**TO220 PACKAGE INFORMATION**



Symbol	Dimensions In Millimeters		Dimensions In Inches	
	MAX	MIN	MAX	MIN
A	10.300	9.700	0.406	0.382
A1	8.840	8.440	0.348	0.332
A2	1.250	1.050	0.049	0.041
A3	5.300	5.100	0.209	0.201
B	16.200	15.400	0.638	0.606
C	4.680	4.280	0.184	0.169
C1	1.500	1.100	0.059	0.043
D	1.000	0.600	0.039	0.024
E	3.800	3.400	0.150	0.134
G	9.300	8.700	0.366	0.343
H	0.600	0.400	0.024	0.016
K	2.700	2.100	0.106	0.083
L	13.600	12.800	0.535	0.504
M	1.500	1.100	0.059	0.043
N	2.590	2.490	0.102	0.098
T	W0.35		W0.014	
DIA	Φ1.5 TYP.	deep0.2 TYP.	Φ0.059 TYP.	deep0.008 TYP.