

N-Ch 100V Fast Switching MOSFETs

- ★ 100% EAS Guaranteed
- ★ Low $R_{DS(ON)}$
- ★ Low Gate Charge
- ★ RoHs and Halogen-Free Compliant

Product Summary

BVDSS	RDSON	ID
100V	8mΩ	13.5A

Description

The FKS0048 is the high cell density trenched N-ch MOSFETs, which provide excellent $R_{DS(ON)}$ and gate charge for most of the Synchronous Rectification for AC/DC Quick Charger.

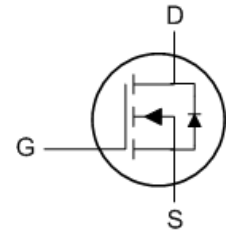
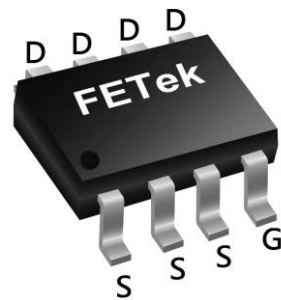
SOP8 Pin Configuration

Absolute Maximum Ratings

Symbol	Parameter	Rating	Units
V_{DS}	Drain-Source Voltage	100	V
V_{GS}	Gate-Source Voltage	±20	V
$I_D@T_A=25^{\circ}C$	Continuous Drain Current ¹	13.5	A
$I_D@T_A=70^{\circ}C$	Continuous Drain Current ¹	10.5	A
I_{DM}	Pulsed Drain Current ²	55	A
EAS	Single Pulse Avalanche Energy ³	33	mJ
I_{AS}	Avalanche Current	15	A
$P_D@T_A=25^{\circ}C$	Total Power Dissipation ⁴	3.1	W
T_{STG}	Storage Temperature Range	-55 to 150	°C
T_J	Operating Junction Temperature Range	-55 to 150	°C

Thermal Data

Symbol	Parameter	Typ.	Max.	Unit
$R_{\theta JA}$	Thermal Resistance Junction-Ambient ¹ ($t \leq 10s$)	---	40	°C/W
	Thermal Resistance Junction-Ambient ¹	---	75	°C/W
$R_{\theta JC}$	Thermal Resistance Junction-Case ¹	---	24	°C/W

**Electrical Characteristics ($T_J=25^\circ\text{C}$, unless otherwise noted)**

Symbol	Parameter	Conditions	Min.	Typ.	Max.	Unit
BV_{DSS}	Drain-Source Breakdown Voltage	$V_{GS}=0V, I_D=250\mu A$	100	---	---	V
$R_{DS(ON)}$	Static Drain-Source On-Resistance ²	$V_{GS}=10V, I_D=13.5A$	---	6.6	8	m Ω
	Static Drain-Source On-Resistance ²	$V_{GS}=4.5V, I_D=11.5A$	---	8.7	10.5	
$V_{GS(th)}$	Gate Threshold Voltage	$V_{GS}=V_{DS}, I_D=250\mu A$	1.2	---	2.3	V
I_{DSS}	Drain-Source Leakage Current	$V_{DS}=80V, V_{GS}=0V, T_J=25^\circ\text{C}$	---	---	1	uA
		$V_{DS}=80V, V_{GS}=0V, T_J=55^\circ\text{C}$	---	---	5	
I_{GSS}	Gate-Source Leakage Current	$V_{GS}=\pm 20V, V_{DS}=0V$	---	---	± 100	nA
g_{fs}	Forward Transconductance	$V_{DS}=5V, I_D=13.5A$	---	75	---	S
Q_g	Total Gate Charge (10V)	$V_{DS}=50V, V_{GS}=10V, I_D=13.5A$	---	45	---	nC
Q_g	Total Gate Charge (4.5V)		---	19.3	---	
Q_{gs}	Gate-Source Charge		---	9.5	---	
Q_{gd}	Gate-Drain Charge		---	4.8	---	
$T_{d(on)}$	Turn-On Delay Time	$V_{DD}=50V, V_{GS}=10V, R_G=3\Omega, I_D=13.5A$	---	10	---	ns
T_r	Rise Time		---	6.5	---	
$T_{d(off)}$	Turn-Off Delay Time		---	45	---	
T_f	Fall Time		---	7.5	---	
C_{iss}	Input Capacitance	$V_{DS}=50V, V_{GS}=0V, f=1\text{MHz}$	---	3320	---	pF
C_{oss}	Output Capacitance		---	605	---	
C_{rss}	Reverse Transfer Capacitance		---	20	---	

Diode Characteristics

Symbol	Parameter	Conditions	Min.	Typ.	Max.	Unit
I_S	Continuous Source Current ^{1,5}	$V_G=V_D=0V$, Force Current	---	---	5	A
V_{SD}	Diode Forward Voltage ²	$V_{GS}=0V, I_S=1A, T_J=25^\circ\text{C}$	---	---	1.1	V
t_{rr}	Reverse Recovery Time	$I_F=13.5A, di/dt=100A/\mu s, T_J=25^\circ\text{C}$	---	33	---	nS
Q_{rr}	Reverse Recovery Charge		---	150	---	nC

Note :

- 1.The data tested by surface mounted on a 1 inch² FR-4 board with 2OZ copper.
- 2.The data tested by pulsed , pulse width $\leq 300\mu s$, duty cycle $\leq 2\%$
- 3.The EAS data shows Max. rating . The test condition is $V_{DD}=25V, V_{GS}=10V, L=0.3mH, I_{AS}=15A$
- 4.The power dissipation is limited by 150°C junction temperature
- 5.The data is theoretically the same as I_D and I_{DM} , in real applications , should be limited by total power dissipation.

Typical Characteristics

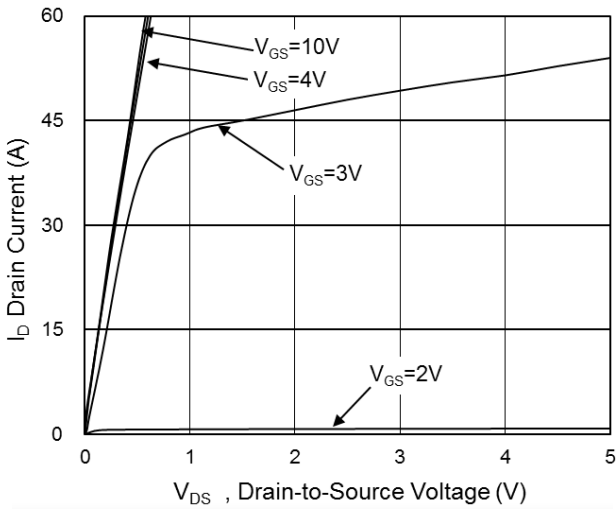

Fig.1 Typical Output Characteristics

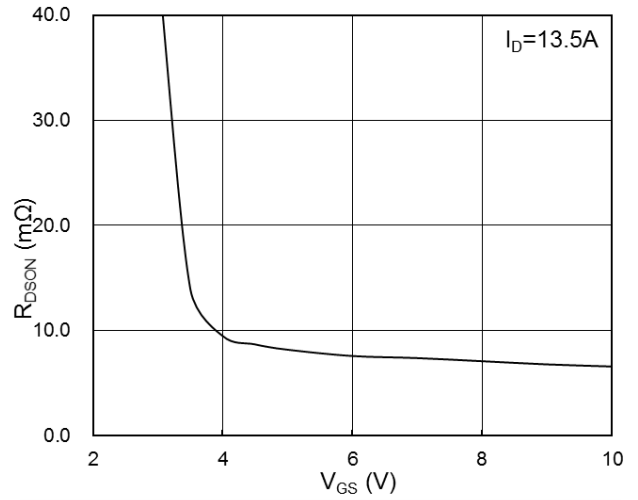

Fig.2 On-Resistance vs. G-S Voltage

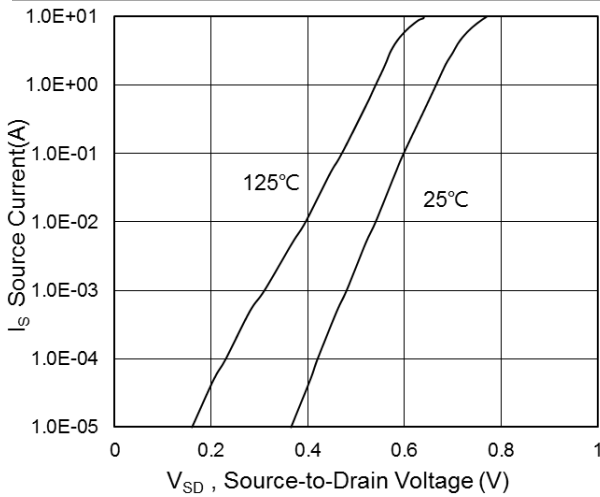

Fig.3 Source-Drain Forward Characteristics

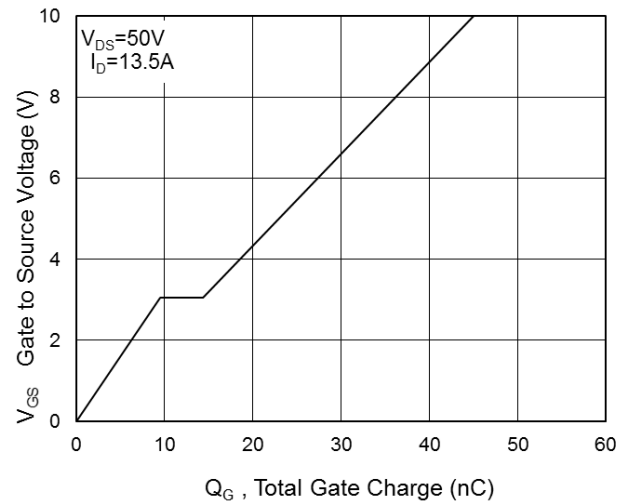

Fig.4 Gate-Charge Characteristics

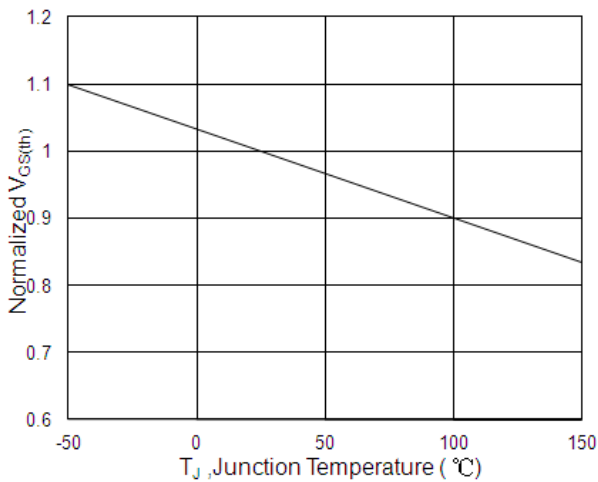

Fig.5 Normalized $V_{GS(th)}$ vs. T_J

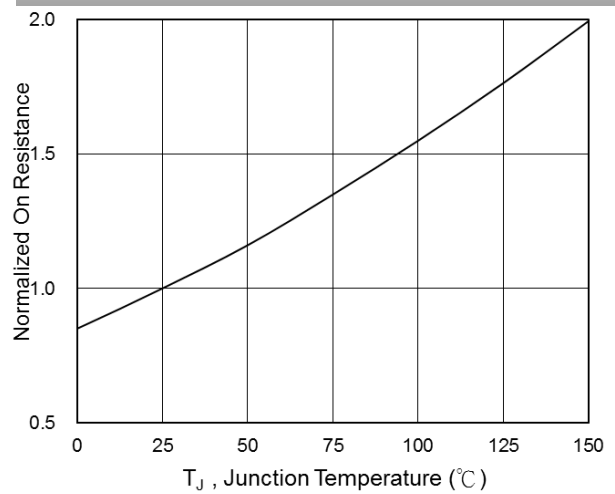

Fig.6 Normalized $R_{DS(on)}$ vs. T_J

N-Ch 100V Fast Switching MOSFETs

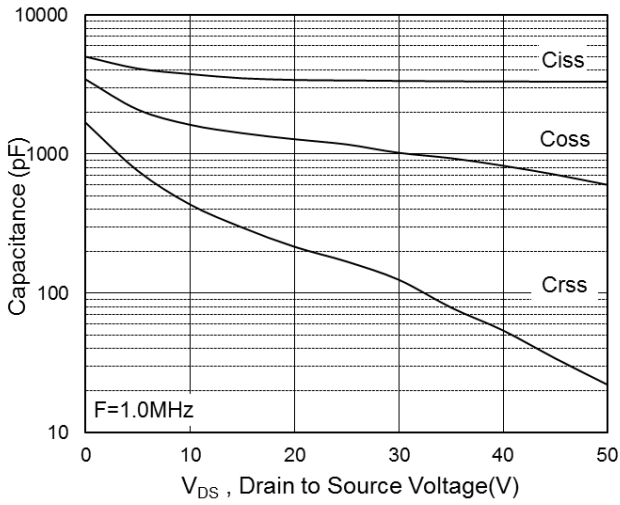

Fig.7 Capacitance

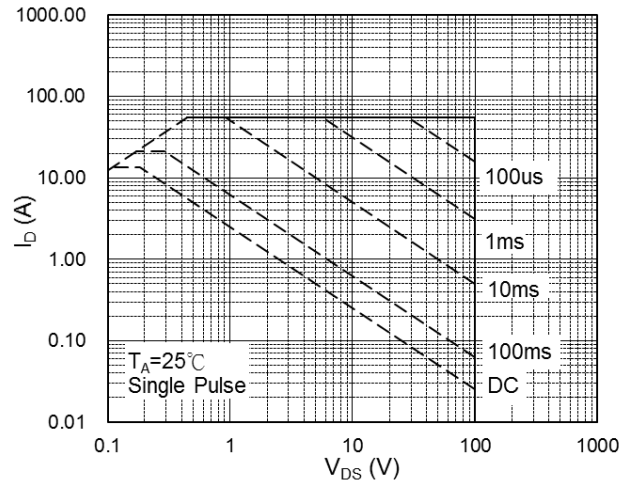

Fig.8 Safe Operating Area

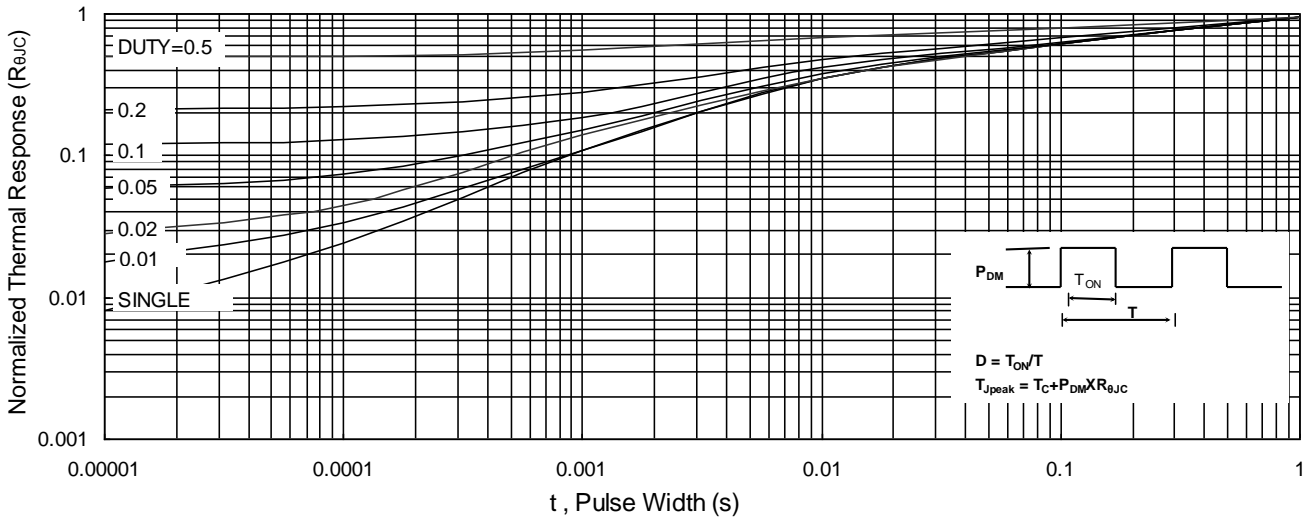

Fig.9 Normalized Maximum Transient Thermal Impedance

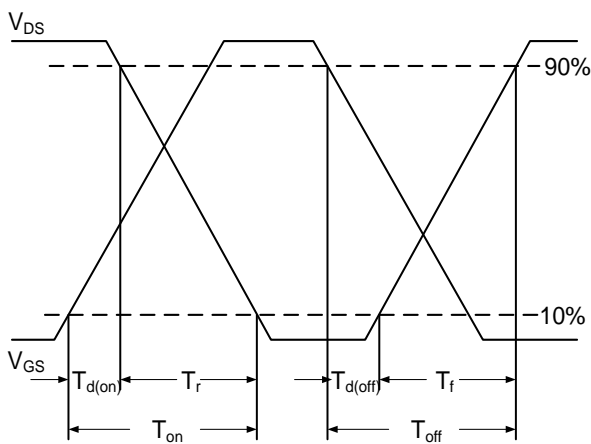

Fig.10 Switching Time Waveform

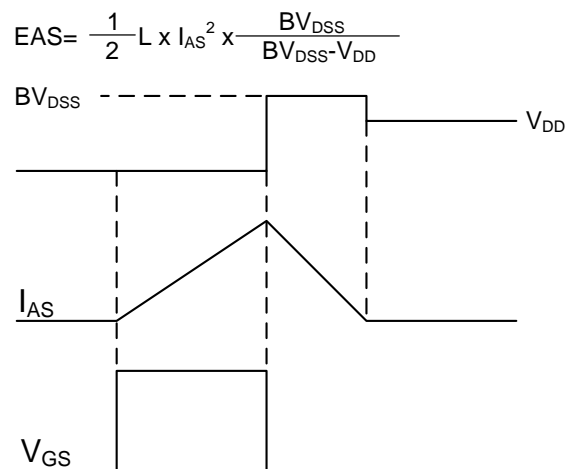

Fig.11 Unclamped Inductive Switching Waveform